

APPROVAL SPECIFICATION

PRODUCT NAME:

KOOMAG PN:KMDC1206M-2- 620T1G

CUSTOMER PN:

CUSTOMER RESPONSE

<input type="checkbox"/> Approval <input type="checkbox"/> Approval with the following changes <input type="checkbox"/> Reject		
APPROVED BY	SIGNATURE	DATE

KOOMAG ENGINEERING SIGNATURE

APPROVED BY	CHECKED BY	ISSUED BY
DATE	DATE	DATE

深圳坤磁科技有限公司
SHENZHEN KOOMAG TECHNOLOGY CO., LTD

Address: B503, Building B, HuaChuangDa Headquarters Building, Bao'an 49 District, Shenzhen

KMDC1206M-2-620T1G

General Description

1. This specification applies to the KMDC1206 series of Common Mode Choke.10/100/1000MHz Ethernet Application.
2. Operating Temperature Range : -40 ~ +105°C ,Storage condition : Temperature -10 ~ +40 °C , Relative humidity 40%~60%.

Appearance & Shape

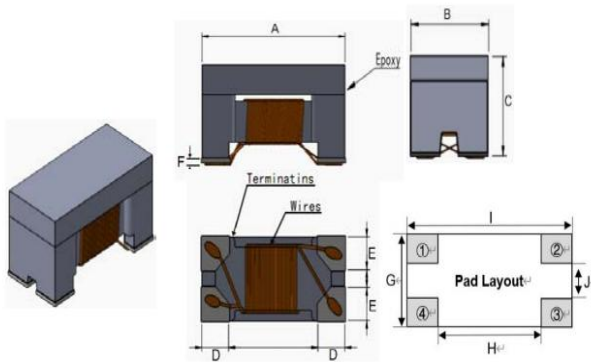

Dimension (Unit:mm)

Series:	KMDC1206M-2- 600T1G
A (mm)	3.4±0.2
B (mm)	1.6±0.2
C (mm)	2.0±0.2
D (mm)	0.64±0.1
E (mm)	0.63±0.1
F (mm)	0.12(TYP.)
G (mm)	1.7
H (mm)	2.4
I (mm)	3.7
J (mm)	0.5

Part Number

KMDC	1206	M	-	2	-	620	T	1G
A	B	C		D		E	F	G

- A:Series
- B:Dimension
- C:Material
- D:Number of Lines
- E:Inductance
- F:Taping and Reel
- G:Speed

Equivalent Circuit / Materials

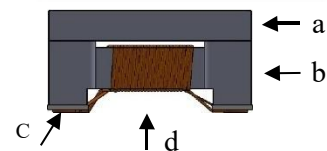
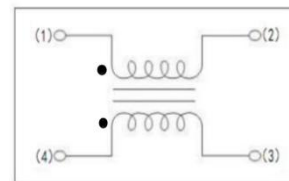

NO.	Description	Specification
a	Upper Plate	Ferrite
b	Core	Ferrite Core
c	Termination	Ag/Ni/Sn
d	Wire	Enameled Copper Wire

Electrical Characteristics

Part No.	Inductance(uH) [100kHz/0.1V] Min.	Capacitance (pF)Max	Rated Current (mA)	DC Resistance Max.(Ω)	Withstand Volt. (Vdc) max.	Rated Volt. (Vdc)	IR (Ω) min.
KMDC1206M-2-620T1G	62	13	200	1.1	125	50	10M

Curve Frequency(MHz)

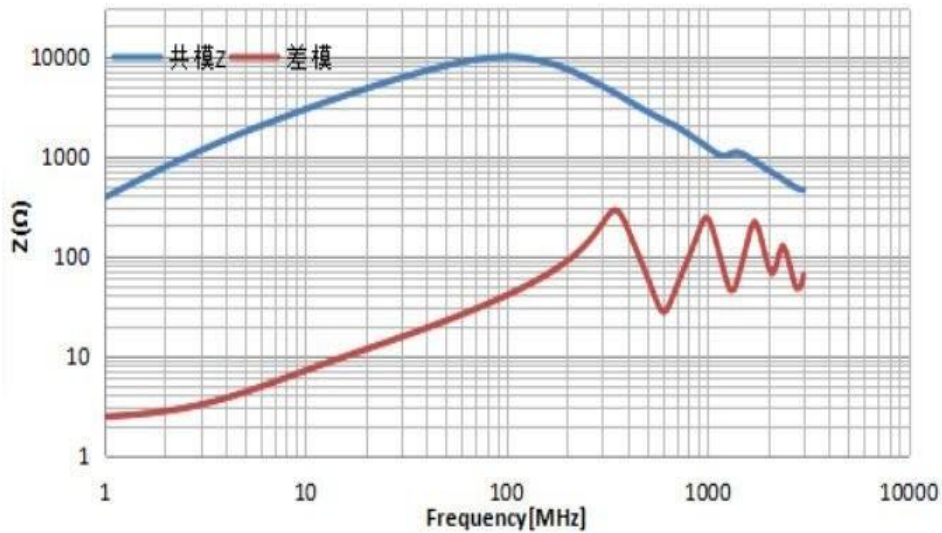

General Reflow Profile & Iron Soldering

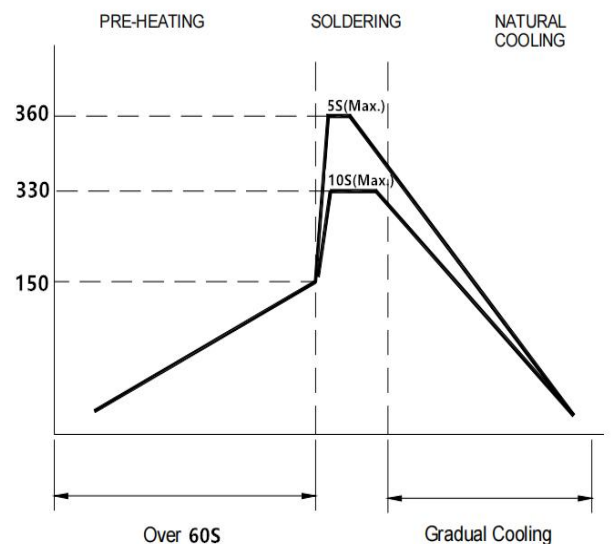
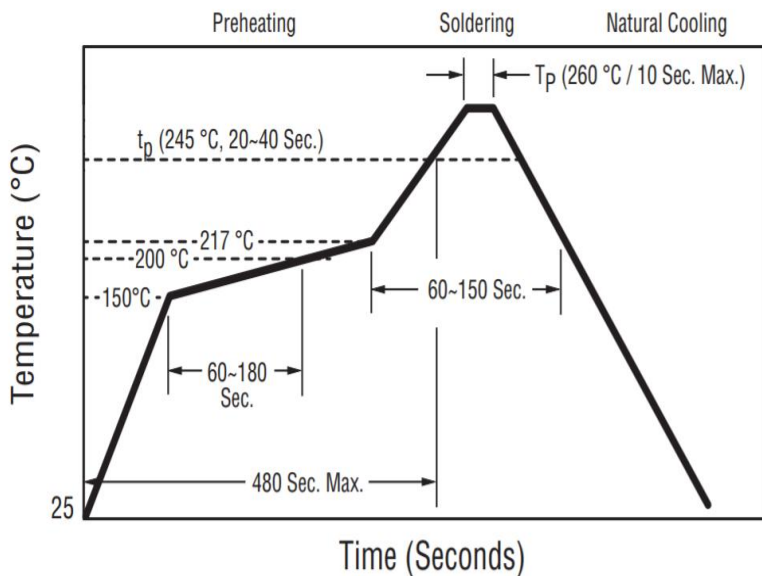

Packaging

(1) Tape Dimensions(Unit:mm)

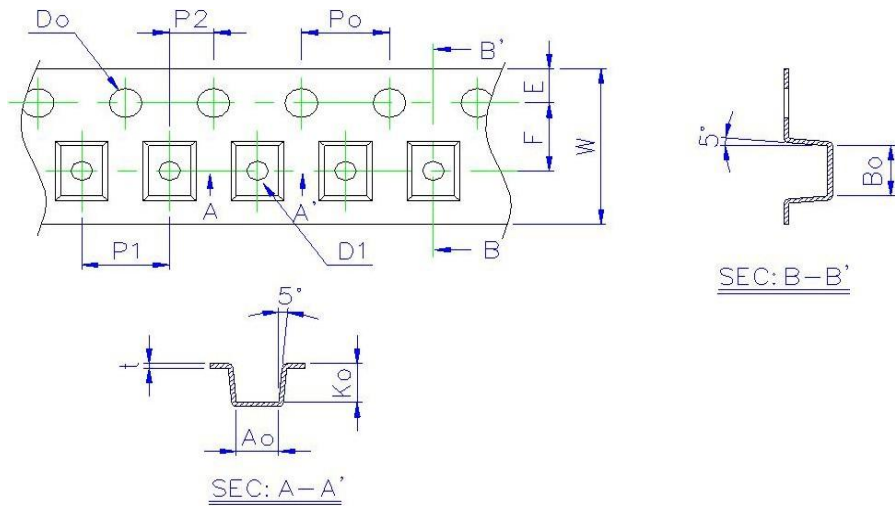

Size	Ao(mm)	Bo(mm)	Ko(mm)	W(mm)	E(mm)	F(mm)	Po(mm)	P1(mm)	Do(mm)
KMDC1206	3.50±0.10	1.88±0.10	2.10±0.10	8.00±0.20	1.75±0.10	3.50±0.05	4.0±0.05	4.0±0.10	1.5+0.1,-0

(2) Reel

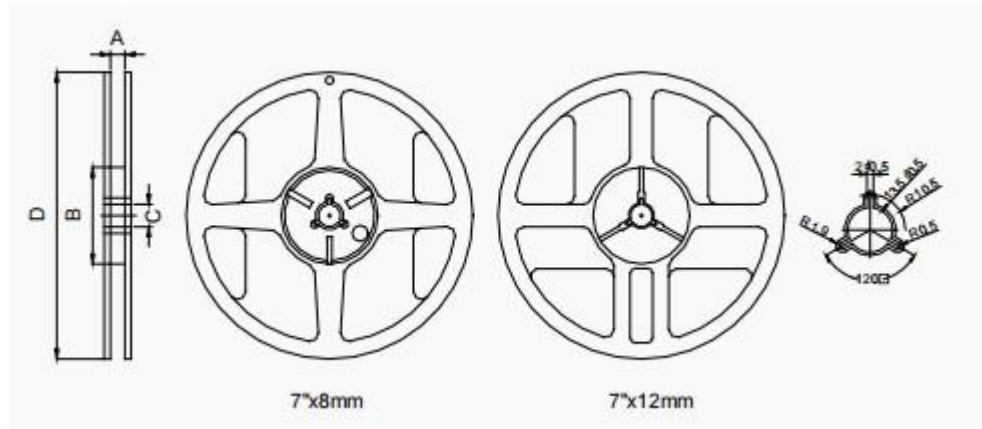

Type	A(mm)	B(mm)	C(mm)	D(mm)
7"x8mm	9.0±0.5	60±2	13.5±0.5	178±2
7"x12mm	13.5±0.5	60±2	13.5±0.5	178±2

Part No.	Tape	MPQ
KMDC1206M-2-620T1G	Embossed Tape	2000PCS